

MaxMotion

PERFORMANCE DATA SHEET

Meets or exceeds MEPS, as described by the US DOE in docket 10CFR431 and NRCAN's Amendment 14

Catalogue #: **MPS-122RB**

HP	kW	Voltage	S.F. @ 60Hz	Efficiency	Power Factor	Frame	Design	L.R. Amps
0,5	0,37	575	1,15	75,0%	0,850	56C	B	8

60 Hz								
FLA							Code	F.L. RPM
208	230	416	460	480	575	600		
/	/	/	/	/	0,6	/	K	3460

50 Hz								
FLA			S.F. @ 50Hz	Efficiency	Power Factor	Code	F.L. RPM	
190	380	415						
/	/	/	/	/	/	/	/	

Wgt. Lbs	PH	Duty	Insul. Class	Amb.	Elevation	Temp. Rise° C
29	3	Cont.	F	40°C	1000M (3300 Ft)	50

% Efficiency		% Power Factor		Torque		Winding Resist. Ω	Safe Cold Start (Secs)
Full Load:	75,0%	Full Load:	0,85	Full Load Ft/Lbs	0,8		
3/4 Load:	73,6%	3/4 Load:	0,77	Locked Rotor %	275	/	12
1/2 Load:	57,9%	1/2 Load:	0,60	Break Down %	364	/	12

Rotor Inertia Wk2 Lb-Ft2	Max Load Inertia Wk2 Lb-Ft2	Shaft Material	Frame Material	DE Bracket Type	ODE Bracket Type	Enclosure	NEMA Rating	Lead Wire Size
/	/	304SS	Stainless Steel			TENV	IP69K	16AWG

Ball Bearings		Grease	Mount Type	Orientation	Paint	Sound Pressure @ 3FT	Sound Power
DE	ODE						
6205	6205	Sealed Bearings	Footless	Horizontal	-	/	/

Inverter Duty. Motor meets MG1 parts 31.4.4.2	Constant Torque Range	Variable Torque Range	Constant HP RPM
	10:1	20:1	5400

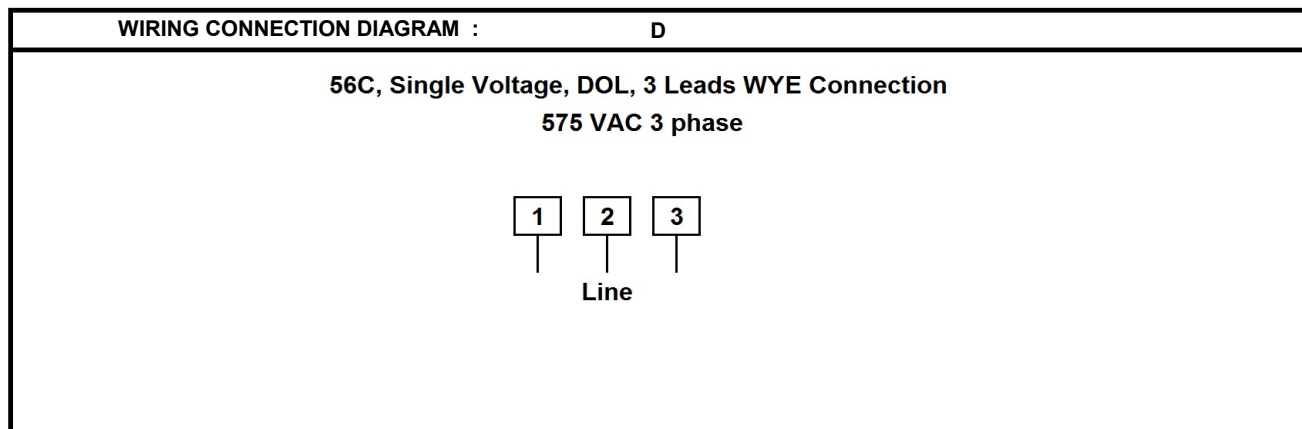

Date: 2024-01-26
 Customer: _____
 Contact: _____
 Submittee: J.C. Lavallée

Catalogue #: **MPS-122RB**

Meets or exceeds MEPS, as described by the US DOE in docket 10CFR431 and NRCan's Amendment 14

HP	VAC	RPM	Enclosure	Frame	Frequency	Design	Poles	LR Code Letter	Insulation Class	Temp. Rise °C
0,5	575	3460	TENV	56C	60	B	2	K	F	50

	0Hz	6Hz	15Hz	30Hz	45Hz	60Hz	75Hz	90Hz	105Hz	120Hz
Amps	0,6	0,6	0,6	0,6	0,6	0,6	0,6	0,6	0,6	0,6
RPM	0	346	865	1730	2595	3460	4325	5190	6055	6920
Torq ft.lb	0,61	0,61	0,76	0,76	0,76	0,76	0,61	0,51	0,43	0,38
Peak Tq ft.lb	1,07	2,14	2,14	2,14	2,14	2,14	1,71	1,43	1,22	1,07
HP	0	0,0	0,1	0,3	0,4	0,5	0,5	0,5	0,5	0,5

	Locked Rotor	Pull-Up	Breakdown	Rated Load	Idle	Duty	S. F.	Ambient	Elevation	dBa @ 1M
Speed (RPM)	0,0	1512	2880	3460	3600	Continuous	1,15	40°C	3,300 ft	/
Current (Amps)	8,0	6,8	4,8	0,6	0,4	VFD Rating: Meets MG1 parts 31.4.4.2				
Torque (ft-lbs)	2,1	1,8	2,8	0,8	0,0	CT :	10:1	VT :	20:1	

Motor Speed Data

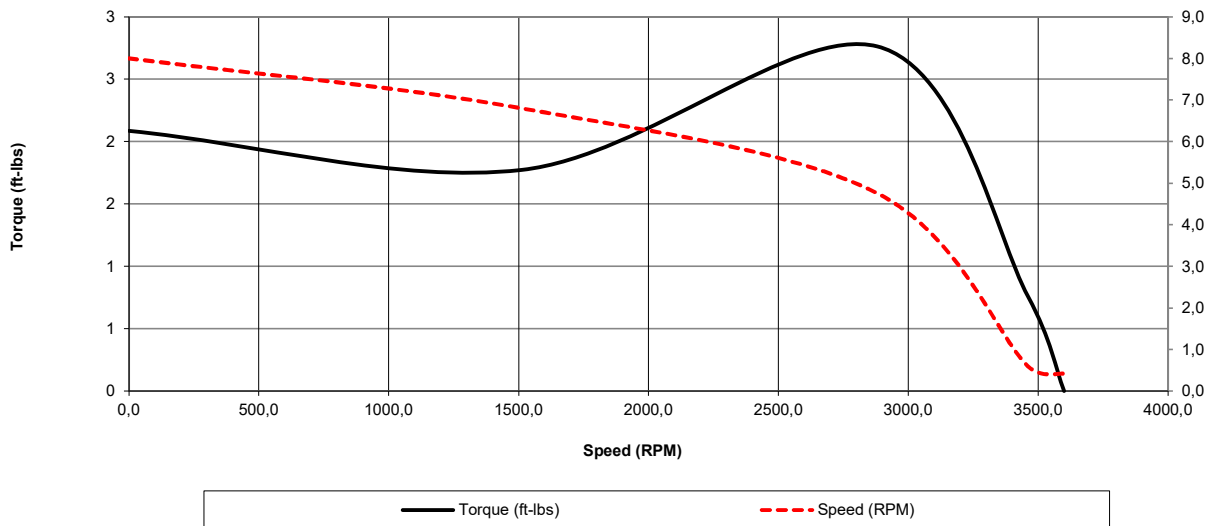

Motor Torque Capability vs RPM

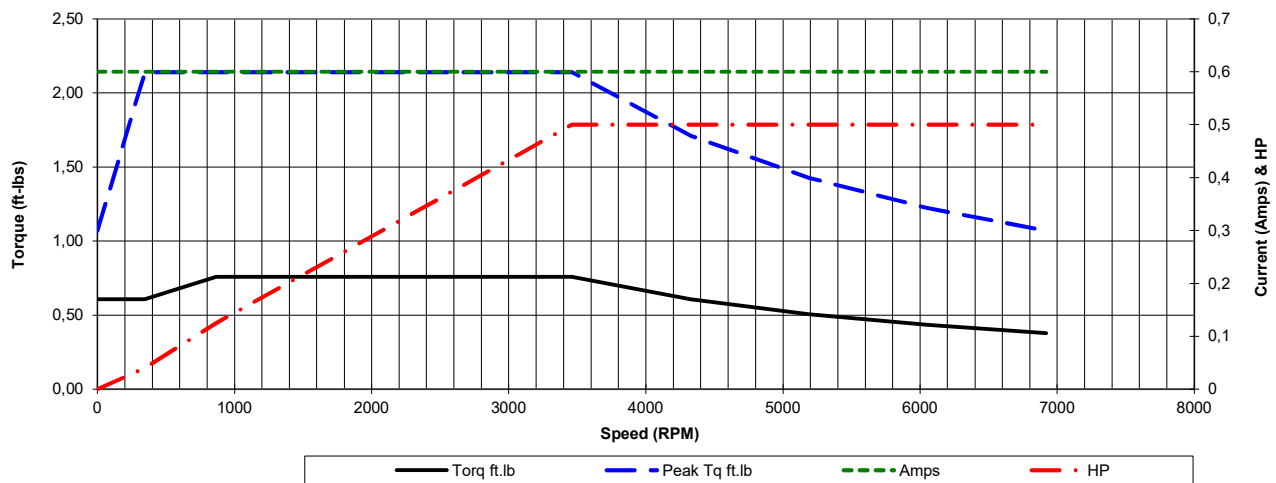

Date: 2024-01-26
 Customer: _____
 Contact: _____
 Submittee: J.C. Lavallée

Catalogue #: **MPS-122RB**

Meets or exceeds MEPS, as described by the US DOE in docket 10CFR431 and NRCan's Amendment 14

HP	VAC	RPM	Enclosure	Frame	Frequency	Design	Poles	LR Code Letter	Insulation Class	Temp. Rise °C
0,5	575	3460	TENV	56C	60	B	2	K	F	50

Load %	0%	25%	50%	75%	100%	125%	150%
Amps	0,42	0,46	0,49	0,53	0,60	0,75	0,90
Torq ft/lbs	0	0,18	0,37	0,56	0,76	0,96	1,16
RPM	0	3565	3530	3495	3460	3425	3390
Eff	0	56,18	64,14	69,09	75,00	72,00	69,94
PF	0	36,6	60	77	85,0	86,7	89,3

	Locked Rotor	Pull-Up	Breakdown	Rated Load	Idle	Duty	S. F.	Ambient	Elevation	dBA @ 1M
Speed (RPM)	0	1512	2880	3460	3600	Continuous	1,15	40°C	3,300 ft	/
Current (Amps)	8	6,8	4,8	0,6	0,42	VFD Rating: Meets MG1 parts 31.4.4.2				
Torque (ft-lbs)	2,09	1,77	2,76	0,76	0,0	CT	10:1	VT	20:1	

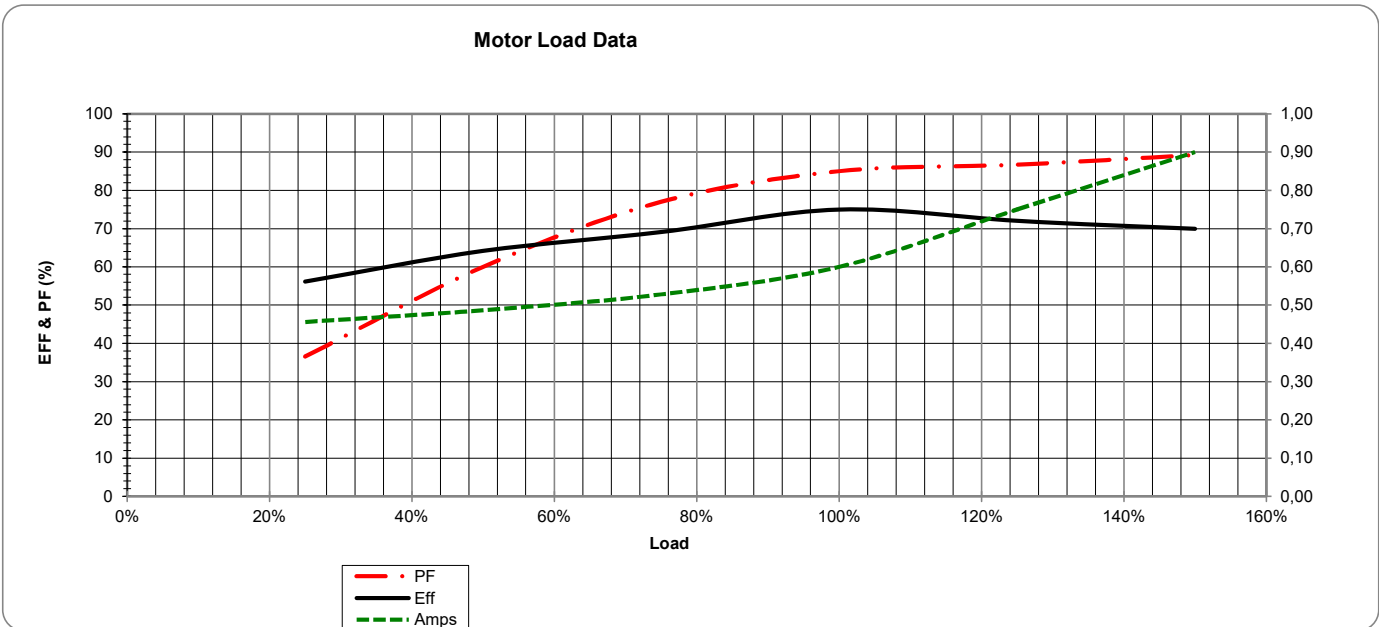
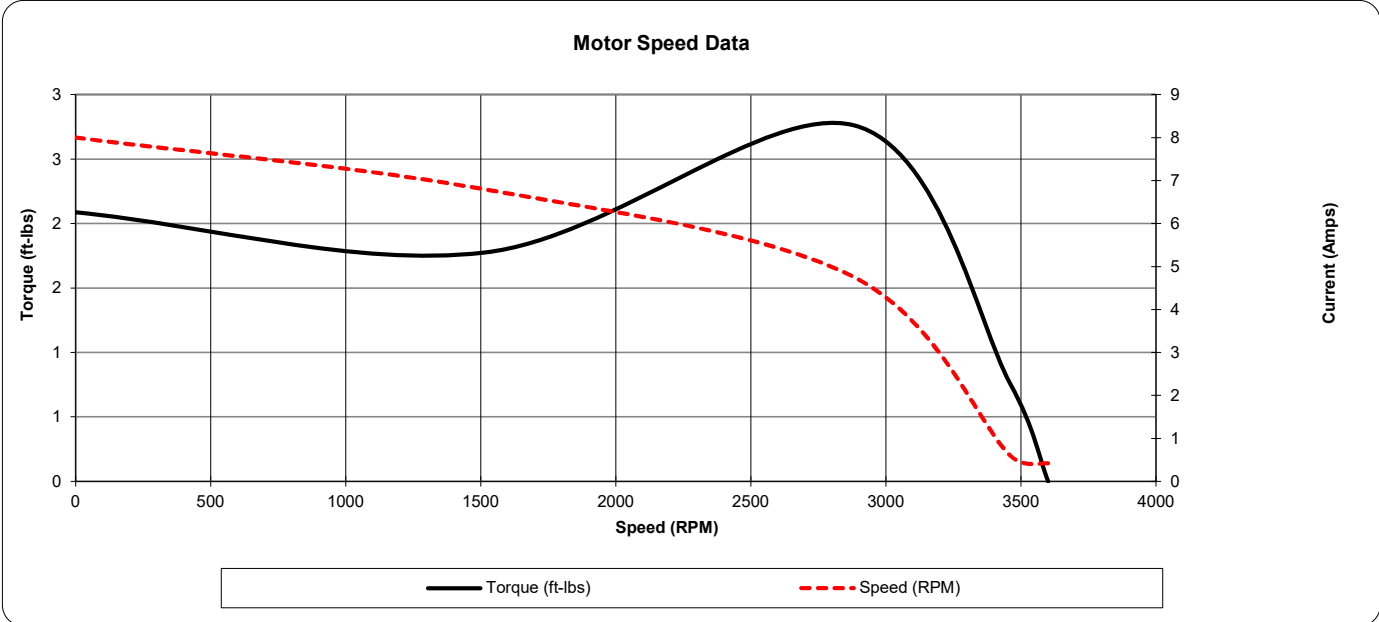

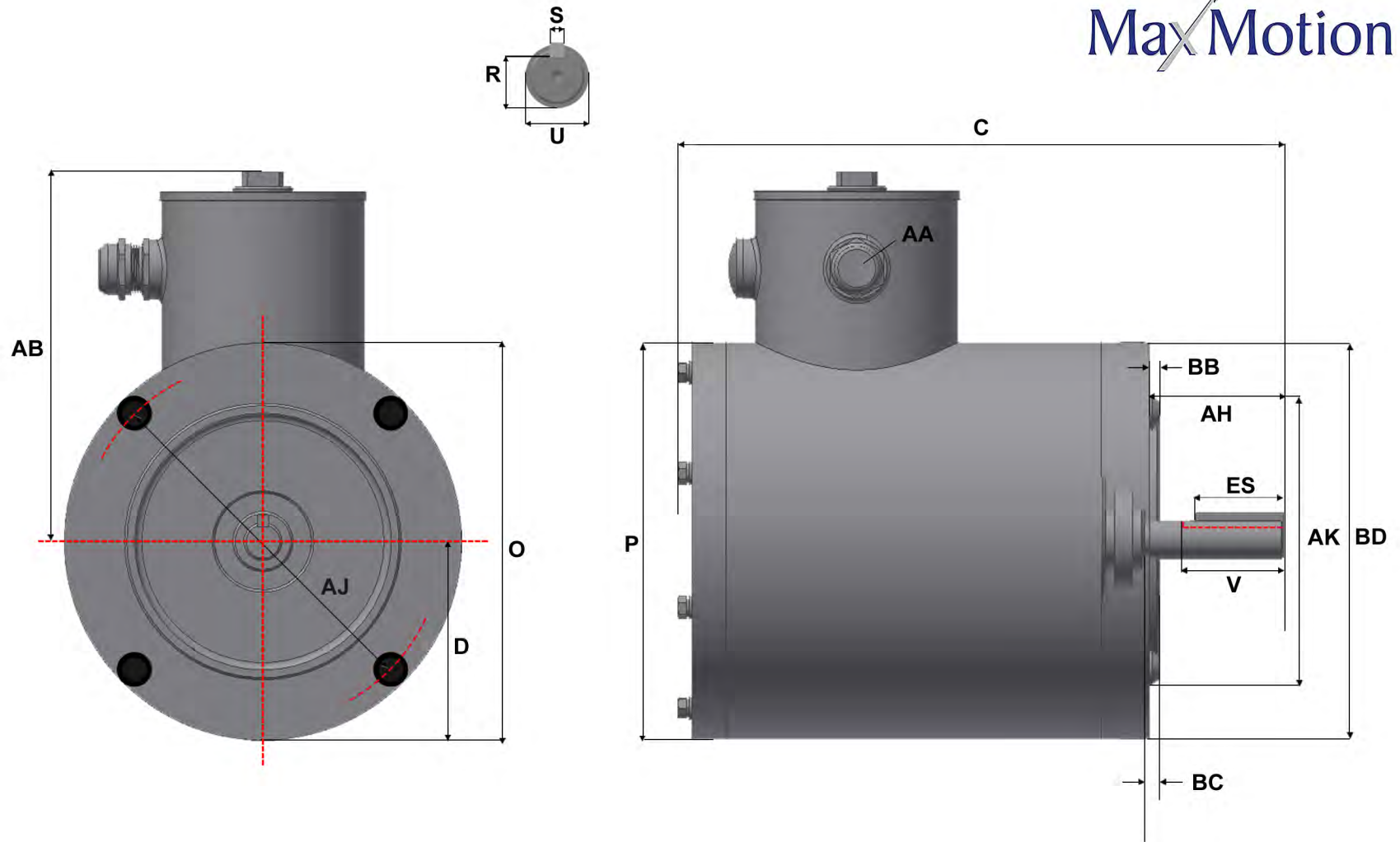

Version: 1WTI		Revised: 02-10-2020		HP	RPM	FRAME	ENCLOSURE	MQS/MPS-122RB					
Customer is responsible in determining that MEP product will fit/perform suitably in the intended application				1/2	3600	56C	TENV						
A	B	C	D	E	2E	2F	G	H	O	P	R	S	
0.00	0.00	9.80	3.50	0.00	0.00	0.00	0.00	0.00	6.73	6.45	0.517	0.188	
T	U	V	AA	AB	AH	AJ	AK	BA	BB	BC	BD	ES	
0.00	0.6250	1.496	1/2 NPT	5.95	2.06	5.875	4.50	0.00	0.16	-0.19	6.45	1.41	

PREMIUM DESIGN B NEMA 12-12

304 GRADE STAINLESS STEEL TENV TOTALLY ENCLOSED
NON-VENTILATED & TEFC TOTALLY ENCLOSED FAN COOLED

MaxMotion

Applications:

A durable and versatile motor design that can be base or flange mounted to equipment operating in wet and severe conditions, and where wash down duty and corrosive elements are found such as in the food processing, bottling and conveyor Industries.



Features:

Design - NEMA standard MG-1, Design B meets MG-1 Part 31

Agency listings and standard - Meets or exceeds MEPS (Minimum Efficiency Performance Standards) as described by US Department of Energy in docket 10CFR431 and Natural Resources Canada's Amendment 14. Also CSAus and CE Certified.

Service Factor - 1.15

Electrical Supply - At 60Hz: 575V and 230/460V dual rated and at 50Hz: 190/380.

Windings - Highest quality Enamel coated Corona resistant inverter duty magnet wire. VPI with additional dip and bake.

Insulation - Non hygroscopic class F with class B temperature rise

Voltage and frequency variation - +/- 10% as based on two voltage points of the motor being either 230 / 460 or 333 / 575

Bearing - Double sealed with Lithium grease -30 Deg to 180 Deg C

Enclosure Protection - Meets Ingress Protection Standard IP69K

Construction - Paint free with all 304 Stainless steel housing and shaft. Moisture proof sealant on all machined fits and shielded Viton type double lip seal . Four condensation plugs on each end shield for mounting flexibility.

Terminal Box - The round welded terminal box design comes completely encapsulated and offers two points of entry for easy access to the terminals. All while eliminating points where contaminants can build up, and maintaining the motors IP69K rating.

Inverter duty - Inverter Duty 10:1 Constant Torque, 20:1 Variable Torque

Nameplate - Permanently etched to stainless steel housing

Warranty - 24 Months



HP	FL RPM	VOLTS	FRAME	CAT NO.	NOM EFF.	F.L. AMPS	CODE	WT (Lbs)	DE BRG	ODE BRG	"C" Dimension (Inch)
1/3	1725	575	56C	MPS-134RB	73,4	0.44	K	28	6205	6205	9,8
	1725	230/460	56C	MQS-134RB	73,4	1.1/.55	K	28	6205	6205	9,8
	1725	575	56C	MPS-134RBFC	73,4	0.44	K	28	6205	6205	11,59
	1725	230/460	56C	MQS-134RBFC	73,4	1.1/.55	K	28	6205	6205	11,59
1/2	3460	575	56C	MPS-122RB	73,4	0.6	K	29	6205	6205	9,8
	3460	230/460	56C	MQS-122RB	73,4	1.5/.75	K	29	6205	6205	9,8
	1725	575	56C	MPS-124RB	78,2	0.688	K	31	6205	6205	9,8
	1725	230/460	56C	MQS-124RB	78,2	1.72/.86	K	31	6205	6205	9,8
	1725	575	56C	MPS-124RBFC	78,2	0.688	K	31	6205	6205	11,59
	1725	230/460	56C	MQS-124RBFC	78,2	1.72/.86	K	31	6205	6205	11,59
	1155	575	56C	MPS-126RB	75,3	75.3	K	31	6205	6205	9,8
	1155	230/460	56C	MQS-126RB	75,3	1.8/.9	K	31	6205	6205	9,8
3/4	3460	575	56C	MPS-342RB	76,8	0.96	K	33	6205	6205	10,78
	3460	230/460	56C	MQS-342RB	76,8	2.4/1.2	K	33	6205	6205	10,78
	1725	575	56C	MPS-344RB	81,1	0.96	K	33	6205	6205	10,78
	1725	230/460	56C	MQS-344RB	81,1	2.4/1.2	K	33	6205	6205	10,78
	1725	575	56C	MPS-344RBFC	81,1	0.96	K	33	6205	6205	12,57
	1725	230/460	56C	MQS-344RBFC	81,1	2.4/1.2	K	33	6205	6205	12,57
	1155	575	56C	MPS-346RB	81,7	1.04	K	34	6205	6205	10,78
	1155	230/460	56C	MQS-346RB	81,7	2.6/1.3	K	34	6205	6205	10,78
1	3470	575	56C	MPSP-102RB	77	1.12	K	35	6205	6205	12,57
	3470	230/460	56C	MQSP-102RB	77	2.8/1.4	K	35	6205	6205	12,57
	3470	575	56C	MPSP-102RBNV	77	1.12	K	35	6205	6205	10,78
	3470	230/460	56C	MQSP-102RBNV	77	2.8/1.4	K	35	6205	6205	10,78
	1765	575	56C	MPSP-104RB	86,7	1.216	K	36	6205	6205	12,57
	1765	230/460	56C	MQSP-104RB	86,7	3.01/1.52	K	36	6205	6205	12,57
	1765	575	56C	MPSP-104RBNV	86,7	1.216	K	36	6205	6205	10,78
	1765	230/460	56C	MQSP-104RBNV	86,7	3.01/1.52	K	36	6205	6205	10,78
	1165	575	56C	MPSP-106RB	82,5	1.4	K	36	6205	6205	12,57
	1165	230/460	56C	MQSP-106RB	82,5	3.5/1.75	K	36	6205	6205	12,57
1.5	3470	575	56C	MPSP-152RB	84	1.68	K	28	6205	6205	12,57
	3470	230/460	56C	MQSP-152RB	84	4.2/2.1	K	28	6205	6205	12,57
	3470	575	56C	MPSP-152RBNV	84	1.68	K	28	6205	6205	11,96
	3470	230/460	56C	MQSP-152RBNV	84	4.2/2.1	K	28	6205	6205	11,96
	1750	575	56C	MPSP-154RB	86,5	1.76	K	36	6205	6205	12,57
	1750	230/460	56C	MQSP-154RB	86,5	4.4/2.2	K	36	6205	6205	12,57
	1750	575	56C	MPSP-154RBNV	86,5	1.76	K	36	6205	6205	11,96
	1750	230/460	56C	MQSP-154RBNV	86,5	4.4/2.2	K	36	6205	6205	11,96
	1150	575	56C	MPSP-156RB	87,5	1.96	K	36	6205	6205	13,75
	1150	230/460	56C	MQSP-156RB	87,5	4.9/2.45	K	36	6205	6205	13,75
2	1760	575	56C	MPSP-204RB	86,5	2.16	K	36	6205	6205	13,75
	1760	230/460	56C	MQSP-204RB	86,5	5.8/2.7	K	36	6205	6205	13,75
	1760	575	56C	MPSP-204RBNV	86,5	2.16	K	40	6205	6205	13,75
	1760	230/460	56C	MQSP-204RBNV	86,5	5.8/2.7	K	40	6205	6205	13,75
	1740	575	145TC	MPSP-204TRB	86,5	2.16	K	49	6205	6205	13,81
3	1760	575	56C	MPSP-304TRB-56C	89,5	3.2	K	63	6205	6205	15,52
	1760	230/460	56C	MQSP-304TRB-56C	89,5	04-août	K	63	6205	6205	15,52

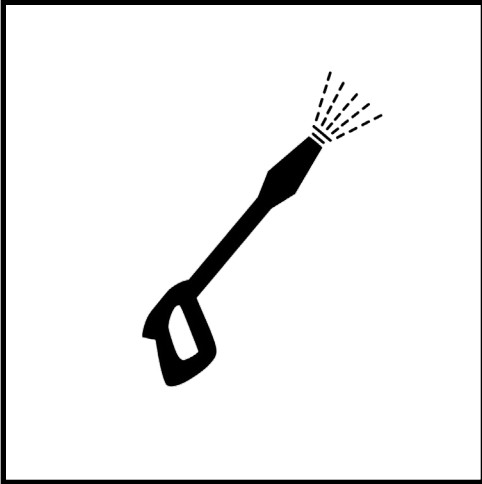

When this power wash icon is displayed, this means the fixture is rated IP69K.

What is IP69K?

The IP69K rating is for applications where high pressure and high temperature wash-down are used to sanitize equipment. The IP69K test specification was initially developed for road vehicles, especially those that need regular intensive cleaning (dump trucks, cement mixers, etc.), but has been widely adopted in the Food & Beverage industries as a test of products to withstand sanitary washdown.

More specifics on IP69K

In applications where devices were regularly exposed to high-pressure or high temperature wash downs, the highest ratings of IP68 was sometimes found to be insufficient. Therefore, a special rating was created by ISO to test this intensive cleaning. In the IEC 60529 rating system, IP6 refers to the product's ability to resist ingress of dust. The 69K refers to the product's ability to resist ingress of high temperature (steam) / high pressure water.

Only if the device passes this test can it be considered IP69K rated and used in harsh environments with high pressure / steam cleaning.

Testing procedure per ISO 20653:
(depicted in image to right)

- A spray nozzle that is fed with 80°C water at 80–100 bar (~1160-1450) and a flow rate of 14–16 L/min.
- The nozzle is held 10-15cm from the tested device at angles of 0°, 30°, 60° and 90° for 30 seconds each.
- The test device sits on a turntable that rotates once every 12 seconds.

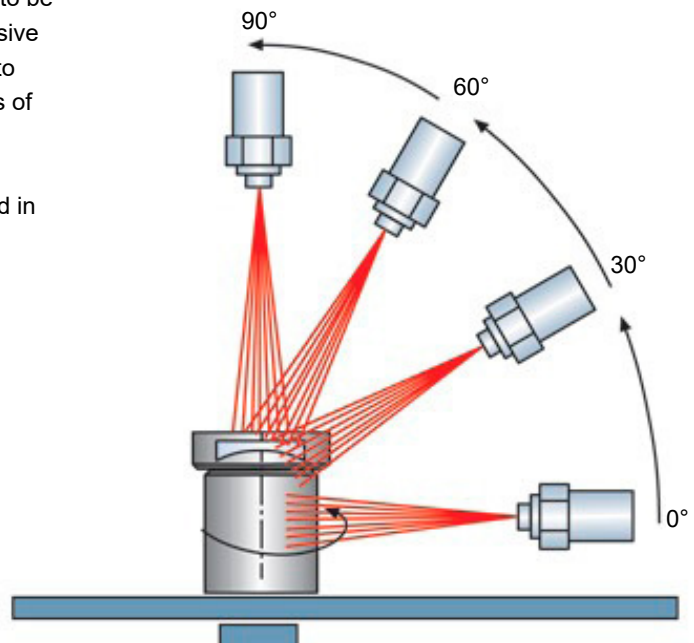

IP68, IP69 and IP69K - The facts

Even though you can do an internet search for IP69, it is important to note that there is no IP69 rating. The IP chart goes from IP68 to IP69K. In addition, just because IP69K is a higher number does not mean the coverage or rating is higher or better than IP68. In fact, IP68 and IP69K are very different ratings. While both share the same first digit "6" which is protection against the ingress of solid objects and are rated as dust tight, that is where the similarity ends. IP68 is rated for prolonged immersion in water, IP69K as noted above involves pressure washing at high temperatures.